

# DILATING DISK™ VALVE

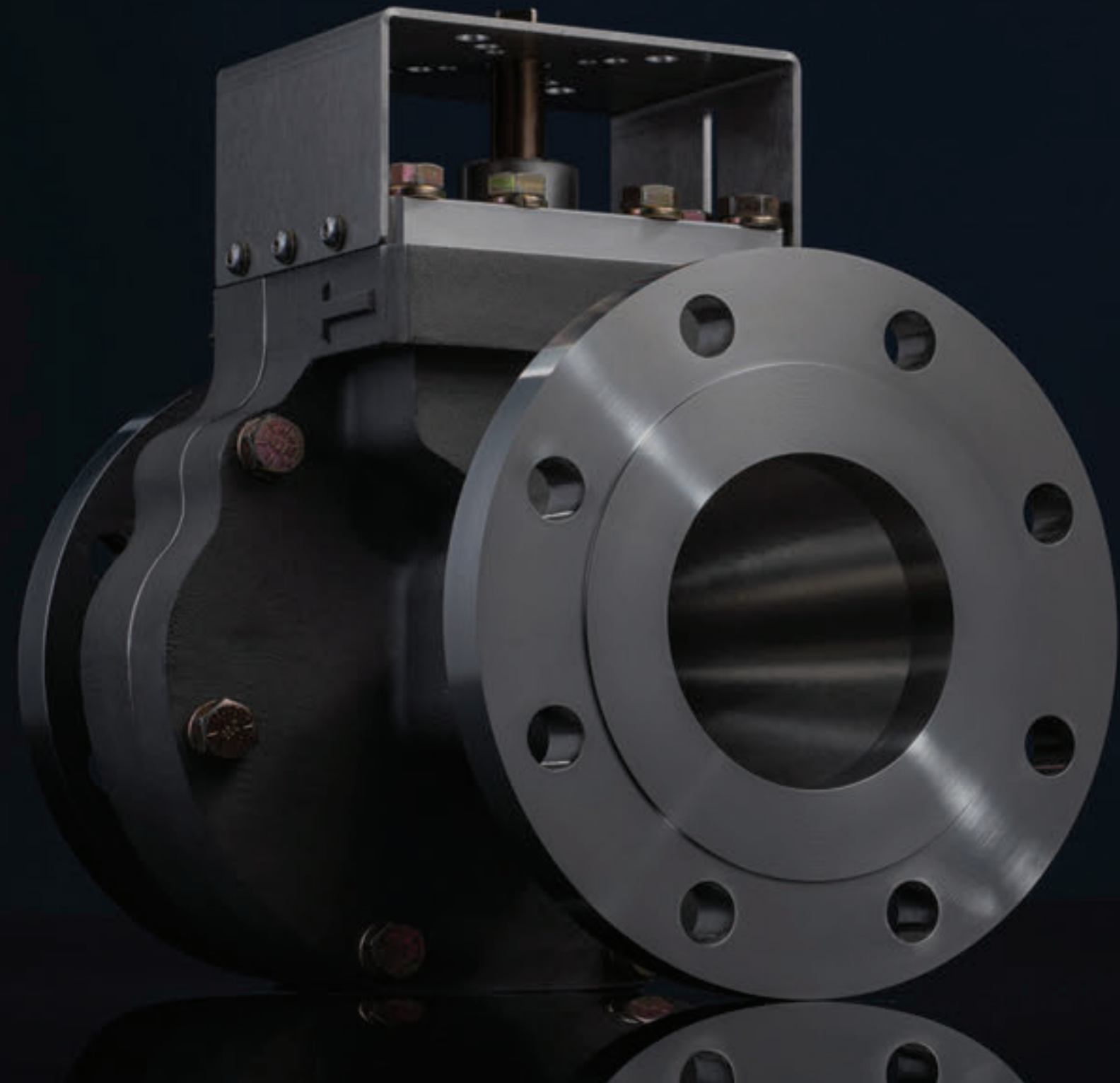

## TABLE OF CONTENTS

- 02 **Welcome**
- 04 **Installed Base**  
Clarke Valve works with organizations worldwide to deliver optimized flow control in a broad array of industries and applications.
- 06 **Patents**  
Reference listing of Clarke Valve's intellectual property.
- 08 **Product Line**  
The Dilating Disk™ Valve offers complete versatility across ¼" up to 12" piping. Available in pressure classes up to ASME 1500# and multiple different end connections.
- 10 **Product Quality & Certifications**  
Clarke Valve is dedicated to providing the highest quality industrial valves to our customers, defect-free, and on time.
- 12 **Dilating Disk™ Valve Multiple Global Patents and Hundreds of Customers**  
Best-in-class results and value for a diverse installed base. The Dilating Disk™ Valve has been successfully deployed in a broad spectrum of customer applications, with some units installed and operational since 2015.
- 15 **Clarke Valve™ Shatters Benchmarks for Reliability and Fugitive Emissions**  
Owing to its unique design, the Dilating Disk™ Valve is one of the few control valves to qualify for both ISO 15848-1 and API 641 certification.
- 16 **Solutions**  
The Dilating Disk™ Valve is designed to seamlessly replace the globe valves that are used for process control in every industry, every day, with zero disruption or switching costs.
- 18 **Replacing Legacy Control Valves with the Dilating Disk™ Valve**  
The selection of orifice sizes to match desirable CV ratings.
- 20 **Extending Operational Life and Ensuring a Tight Seal**  
The 3-piece O-ring groove created by the valve Petals in the closed position as a solution to survive high-cycle fatigue and wear.
- 22 **Precision Throttling and Tight Shutoff with Minimal Torque**  
The Ring Gear as an appropriate means of driving the movement of the Petals to minimize torque.
- 24 **Achieving Tight Shutoff and Extending Component Life**  
The interlocking seal and rib combination as a safeguard against seat leakage, high cycle fatigue, and wear.





**CLARKE VALVE HAS**  
ESTABLISHED ITSELF AS THE  
**PREMIER MANUFACTURER OF**  
THE NEXT GENERATION OF PRECISION  
**FLOW CONTROL**





## INSTALLED BASE

Clarke Valve works with organizations worldwide to deliver optimized flow control in a broad array of industries and applications. Each logo represents a selected example from the Dilating Disk™ Valve installed base.







# PATENTS

Reference listing of Clarke Valve's intellectual property.

## PATENTS

LOW EMISSION BONNET SEAL US 10,612,661	DILATING DISK™ VALVE WITH PIVOT ARMS CN 201510441654.2	DILATING DISK™ VALVE SYSTEM FOR INTERNAL COMBUSTION ENGINES US 09/425,900 US 6,199,531	DILATING DISK™ VALVE WITH PIVOT ARMS IT 15020089.7 IT 2988044
DILATING DISK™ VALVE WITH PIVOT ARMS US 14/462,047 US 8,910,920	DILATING DISK™ VALVE WITH PIVOT ARMS EP 15020089.7	DILATING DISK™ VALVE WITH PIVOT ARMS FR 15020089.7 FR 2988044	DILATING DISK™ VALVE WITH PIVOT ARMS NL 15020089.7 NL 2988044
DILATING DISK™ VALVE US 14/634,002	DILATING DISK™ VALVE WITH PIVOT ARMS JP 2015-134332	DILATING DISK™ VALVE WITH PIVOT ARMS DE 15020089.7 DE 2988044	DILATING DISK™ VALVE WITH PIVOT ARMS ES 15020089.7 ES 2988044
DILATING DISK™ VALVE US 15/392,663 US 9,970,554	DILATING DISK™ VALVE WITH SEALS US 14/795,442 US 9,206,911	DILATING DISK™ VALVE WITH PIVOT ARMS IE 15020089.7 IE 2988044	DILATING DISK™ VALVE WITH PIVOT ARMS GB 15020089.7 GB 2988044
DILATING DISK™ VALVE WITH PIVOT ARMS CA 2,892,194	VALVE HOUSING US 29/530,857 US D800870		



# DILATING DISK™ VALVE PRODUCT LINE

The Dilating Disk™ Valve offers complete versatility across 1/4" up to 12" piping. Available in pressure classes up to ASME 1500# and multiple different end connections.

Identify your valve requirements and contact our engineering team to discuss an optimized solution utilizing the Dilating Disk™ Valve.



MODEL NUMBER	AVAILABLE SIZES	PRESSURE CLASSES	END CONNECTIONS
CV2	1/4" - 1"	150 - 1500	NPT, RF
CV20	1/2" - 3"	150 - 1500	NPT, RF
CV71	1" - 4"	150 - 1500	NPT, RF
CV308	2" - 6"	150 - 600	NPT (up to 4"), RF
CV1345	4" - 12"	150 - 600	NPT (up to 4"), RF



# PRODUCT QUALITY & CERTIFICATIONS

Clarke Valve is dedicated to providing the highest quality industrial valves to our customers, defect-free, and on time.

**W**e are committed to satisfying all customer and applicable requirements and to the continual improvement of our business, products, processes, and quality management system. All valves produced by Clarke are designed, inspected, and tested in strict conformance to the applicable industrial valve standards and codes to ensure maximum product safety and reliability.

From ASME B16.34 to ISO 5211, Clarke Valve proudly conforms to, or maintains certifications for, more than 20 respected industry standards, ensuring seamless integration and zero disruptions when a customer makes the choice to deploy the Dilating Disk™ Valve.

## ISO 9001:2015 CERTIFICATE

The ISO 9000 family of quality management systems standards is designed to help organizations ensure that they meet the needs of customers and other stakeholders while meeting statutory and regulatory requirements related to a product or service.

## ISO 15848-1:2015 CERTIFICATE

“Industrial valves – Measurement, test and qualification procedures for fugitive emissions” outlines the testing requirements for control valves and isolation valves. Control valves must cycle from 40% open to 60% open more than 100,000 times to achieve a CC3 endurance rating, and must allow less than 50 parts per million by volume leakage of methane to achieve the Class AM tightness rating.

## API 641 CERTIFICATION: GROUP A

The American Petroleum Institute (API) 641 standard, “Type Testing of Quarter-Turn Valves for Fugitive Emissions,” applies to all stem seal materials, and requires a stringent maximum allowable leakage of 100 parts per million by volume (PPMv). This API test standard calls for 610 cycles of the valve under extreme temperature fluctuations to evaluate emissions performance over an accelerated life cycle.

## PED MODULE H CERTIFICATE (CE MARKING)

Clarke Valve has implemented, operates and maintains a quality assurance system as described in the Pressure Equipment Directive 2014/68/EU Annex III, Module H for the scope of

“Design and manufacture of dilating disk and/or Dilating Disk™ Valves.”

“The manufacturer is authorized to provide the pressure equipment produced within the scope of the assessed quality assurance system with the following Notified Body Number: CE 0036.”

## CANADIAN REGISTRATION NUMBER (CRN)

The drawings, engineering calculations, and materials of construction for the Dilating Disk™ Valve have been approved by ABSA, TSSA, and ACI, and are exempt in all other Provinces, by virtue of their conformance with the pressure and temperature ratings defined by ASME B16.34.

**Clarke Valve proudly conforms to or maintains certifications to these respected industry standards.**

**ANSI/FCI 70-2**  
*Control Valve Seat Leakage*

**ANSI/ISA-75.02.01-2008**  
*Control Valve Capacity Test Procedure*

**ANSI/ISA-75.17**  
*Control Valve Aerodynamic Noise Prediction*

**ANSI/ISA-75.01.01**  
*Flow Equations for Sizing Control Valves*

**API 598**  
*Valve Inspection and Testing*

**API 641**  
*Type Testing of Quarter-turn Valves for Fugitive Emissions*

**API 689**  
*Collection and Exchange of Reliability and Maintenance Data for Equipment*

**ASME B16.34**  
*Valves – Flanged, Threaded, and Welded*

**ASME B16.5**  
*Pipe Flanges and Flanged Fittings*

**ASME B16.10**  
*Face-to-Face and End-to-End Dimensions of Valves*

**Hazardous Service**  
*ExdII B T6, Class 1, Div 1, Group C&D T6*

**CRN**  
*Canadian Registration Numbers OC20008.25, OC1330.9*

**IEC 60534-2-1**  
*Flow Capacity – Sizing Equations for Fluid Flow Under Installed Conditions*

**IEC 60534-2-3**  
*Flow Capacity – Test Procedures*

**IEC 60534-2-4**  
*Flow Capacity – Inherent Flow Characteristics and Rangeability*

**IEC 60534-7**  
*Control Valve Data Sheet*

**IEC 60534-8-4**  
*Industrial Process Control Valves – Part 8-4: Noise Considerations – Prediction of Noise Generated by Hydrodynamic Flow*

**ISA-RP75.23**  
*Considerations for Evaluating Control Valve Cavitation*

**ISO 15848-1:2015**  
*Industrial valves – Measurement, test and qualification procedures for fugitive emissions*

**ISO 5211**  
*Industrial Valves – Part Turn Actuator Attachments*

**ISO 9001:2015**  
*Quality Management Systems – Requirements*

**MIL-V-24509A**  
*Military Specification – Valves, Flanged, Ball and Plug for Sewage and Sea Water Service*

**MIL-S-901D (NAVY)**  
*Military Specification – Shock Tests (High Impact) Shipboard Machinery, Equipment, and Systems*

**MIL-STD-167-1 (SHIPS)**  
*Department of Defense Test Method – Mechanical Vibrations of Shipboard Equipment (TYPE 1 – Environmental and TYPE II – Internally Excited)*

**MIL-DTL-32632 (NAVSEA)**  
*Detail Specification – Valves, Flow Control, Dilating Disk, for Naval Shipboard Water, Oil, and Gas Service*

**MSS SP-61**  
*Pressure Testing of Steel Valves*

**SIL 3 Certification**  
*IEC 61508:2010 Parts 1-7, CLA 2005077 C001*

**QQ-N-281D**  
*Federal Specification Nickel Copper Alloy Bar, Rod, Plate, Sheet, Strip, Wire, Forgings, and Structural and Special Shaped Sections*



# DILATING DISK™ VALVE MULTIPLE GLOBAL PATENTS AND HUNDREDS OF CUSTOMERS

Best-in-class results and value for a diverse installed base. The Dilating Disk™ Valve has been successfully deployed in a broad spectrum of customer applications.

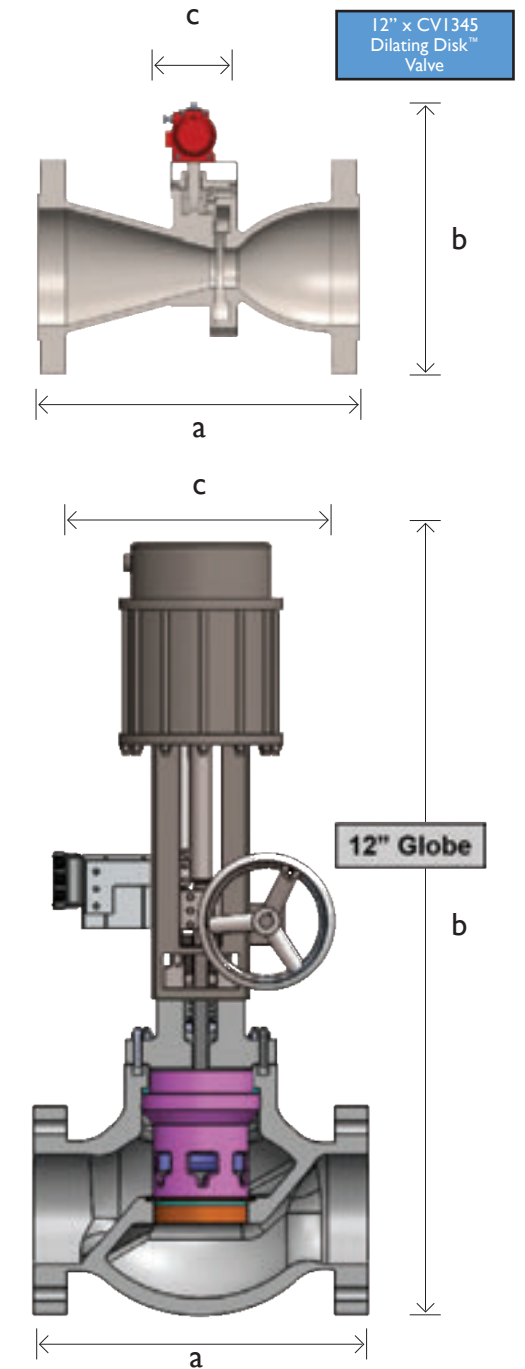

## PROVEN PERFORMANCE

Best-in-class results and value for a diverse installed base. The Dilating Disk™ Valve has been successfully deployed in a broad spectrum of customer applications, with some units installed and operational since 2015.

The only control valve to earn both the API 641 and ISO 15848 certifications. We work with industry leading testing partners like Yarmouth Research and Technology for third party certification of the Dilating Disk™ Valve's capabilities.

In 2018, Yarmouth certified the Dilating Disk™ Valve as the first control valve to achieve the American Petroleum Institute (API) 641 certification for fugitive emissions reduction. In 2019, the Dilating Disk™ Valve shattered existing benchmarks for ISO 15848-1:2015 by limiting fugitive methane emissions to 2 ppm by volume for more than 100,000 mechanical cycles.



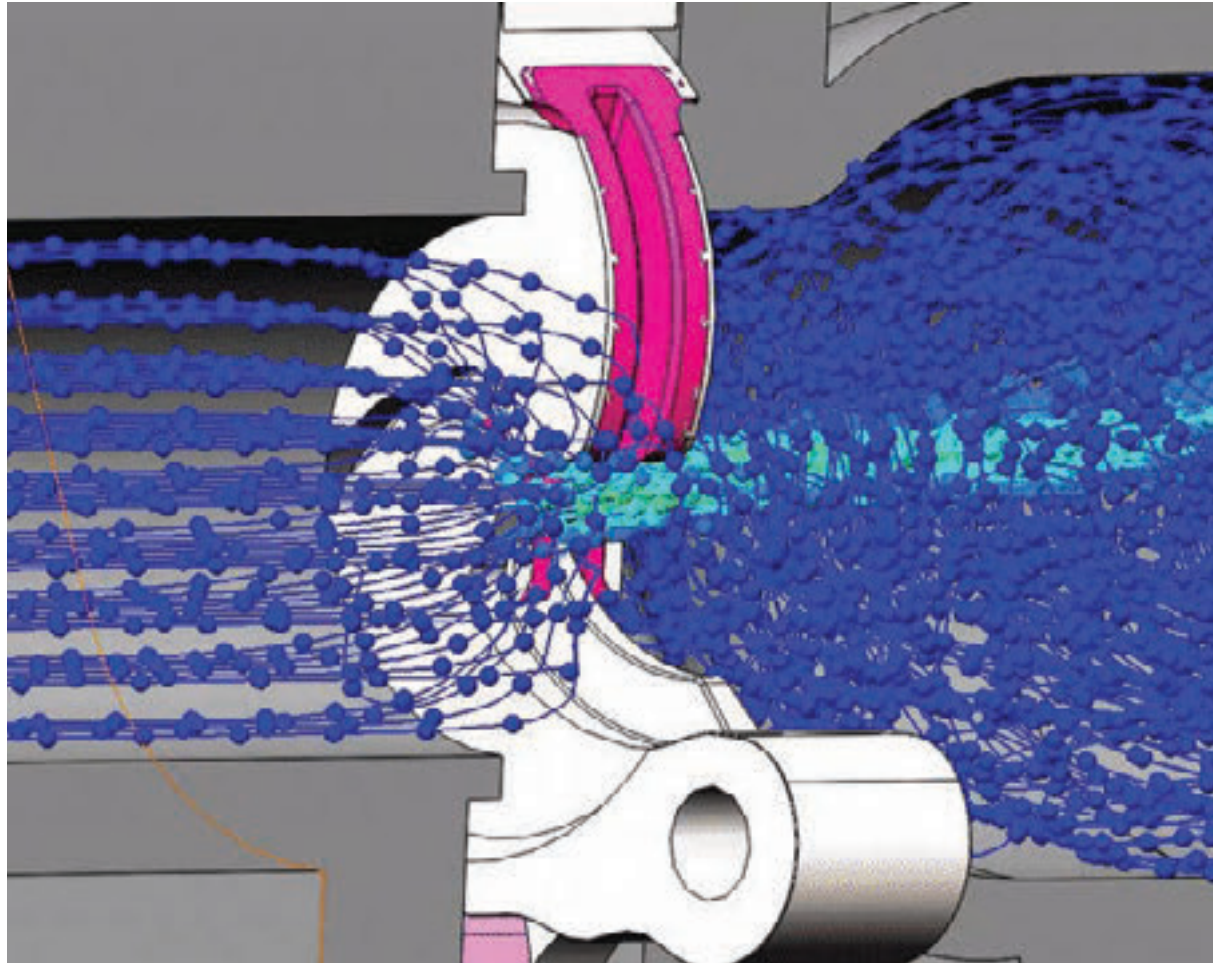

#### UNIQUE FORM

A step change in valve design, perfected over a decade of R&D. The Dilating Disk™ Valve employs a geometry unlike any other industrial valve on the market, providing best-in-class, dynamic process control from a quarter-turn stem.

Three interlocking Petals form the aperture of the Dilating Disk™ Valve. They open perpendicular to the flow of process fluids.

The mechanical operation of the valve is driven by a rugged and efficient Ring Gear, which delivers precise throttling, tight shutoff, and high cycle life while requiring minimal torque.

With a valve body that is 50-80% smaller and lighter than the globe valves it is designed to replace, the Dilating Disk™ Valve provides the same CV (flow rate) at a significantly lower cost.

#### SAME FIT

Plug and play with no added cost and zero risk. Even though the Dilating Disk™ Valve is unlike any other control valve on the market, it fits seamlessly into existing lines.

To eliminate switching costs, the entire Dilating Disk™ Valve product line conforms to the face-to-face dimensions for globe valves defined by the ISA 75.08 and ASME B16.10 standards.

Safety and reliability are the foundation we've built our business on. From ASME B16.34 to ISO 5211, Clarke Valve proudly conforms or maintains certifications for more than 20 respected industry standards, ensuring seamless integration and zero disruptions when a customer makes the choice to deploy the Dilating Disk™ Valve.

#### BETTER FUNCTION

By opening perpendicular to the flow of process fluids, the Dilating Disk™ Valve requires much less operating torque than other control valves; reducing actuator size and energy requirements.

The proprietary design of the Dilating Disk™ Valve's bonnet and stem leads to a 97% reduction of fugitive emissions when compared to "low emissions" globe valves, while eliminating the need for packing adjustments in the field.

# CLARKE VALVE™ SHATTERS BENCHMARKS

Owing to its unique design, the Dilating Disk™ Valve is one of the few control valves to qualify for both ISO 15848-1 and API 641 certification.

Under ISO 15848-1, control valves must cycle from 40% open to 60% open, while meeting one of the tightness class ratings for methane leakage: tightness class CM signifies allowable leakage of  $\leq 500$  parts per million by volume (ppmv); BM is for  $\leq 100$  ppmv; and AM is the world's most stringent standard for methane leakage, at  $\leq 50$  ppmv.

One of the other key ratings addressed by ISO 15848-1 is reliability, as measured by the endurance class that a control valve can surpass, while maintaining a CM tightness class or better: endurance class CC1 signifies 20,000 mechanical cycles completed; CC2 is for 60,000 mechanical cycles; and CC3 is the highest endurance threshold under ISO 15848-1, at 100,000 cycles.

"The Dilating Disk™ Valve has shattered the previously held standards for low emissions by a control valve, as

expected," said Kyle Daniels, President and CEO of Clarke Valve. "It achieved the ISO 15848-1 CC3 endurance rating for 100,000 mechanical cycles, while allowing a maximum of 2 ppmv, during more than 3 weeks of continuous testing. We have clearly demonstrated that we have the best fugitive emissions solution on the market, and we look forward to deploying this technology through the OGC member companies."

Owing to its unique design, the Dilating Disk™ Valve is one of the few control valves to qualify for both ISO 15848-1 and API 641 certification, as confirmed through independent testing by Yarmouth Research and Technology, LLC. API 641 is the American Petroleum Institute's fugitive emissions standard for quarter-turn valves, which is the category of valve the Dilating Disk™ Valve belongs to, and is the most common category of valve in use today.



## ABOUT CLARKE VALVE

Founded in 2011, Clarke Valve™ provides high quality industrial control valves to organizations worldwide. Using aerospace design principles, Clarke has developed the Dilating Disk™ Valve, the first major innovation in valve design in the last fifty years. The Dilating Disk™ Valve is the first control valve to achieve both API 641 and ISO 15848-1 certification, making it the world's most compact, efficient, and environmentally responsible control valve. Clarke Valve technology is currently deployed in a diverse spectrum of markets, including oil and gas, aerospace, chemical, power plants, and water management.

#### DURABLE, HIGH QUALITY

Engineered to last. Clarke Valve is ISO 9001:2015 certified, and maintains the highest quality standards for our materials, manufacturing processes, and products.

#### REFINED THROUGH REAL WORLD TESTING.

The Dilating Disk™ Valve has been subjected to millions of operational cycles in the field. The result is a dependable and efficient design that is infinitely adaptable to new customer applications.

Over time, the Dilating Disk™ Valve design has become even more durable and streamlined. The internal mechanism now uses 7 parts, instead of 22.

We have chosen 316L and CF3M stainless steel as our default materials for fabrication, due to their favorable properties for hardness and corrosion resistance.

However, the Dilating Disk™ Valve can be manufactured from whatever material the customer specifies, with some other examples being carbon steel, MIL-SPEC bronze, nickel, and aluminum.





# SOLUTIONS

The Dilating Disk™ Valve is designed to seamlessly replace the globe valves that are used for process control in every industry, every day, with zero disruption or switching costs.



# THE OPPORTUNITIES ARE ENDLESS.

FROM OIL AND GAS TO POWER PRODUCTION, FROM CHEMICAL PLANTS TO ADVANCED WATER SYSTEMS, NO OTHER GLOBE VALVE PROVIDES THE PRECISION FLOW CONTROL OF THE CLARKE VALVE DILATING DISK™ VALVE.

## OIL & GAS APPLICATIONS

**WE SPECIALIZE IN:**  
Gas Lift, VRU, Gas Compression, Separators, Refinery Valves, Tank Valves

## NAVY AND MARINE

**WE SPECIALIZE IN:**  
Fuel, Oil, Water

## POWER

**WE SPECIALIZE IN:**  
Cooling Water, Mild Steam, Glycol, Fuel Control Valves, Boiler Control Valves, Nuclear

## ADVANCED WATER SYSTEMS

**WE SPECIALIZE IN:**  
Lime Slurry, Water Treatment, Water Control, Municipal

## CHEMICAL PLANTS

**WE SPECIALIZE IN:**  
Vacuum, Oxygen, Gases, Acids

## AEROSPACE

**WE SPECIALIZE IN:**  
Cooling Systems, Fuel Systems, Environmental Control



# REPLACING LEGACY CONTROL VALVES WITH THE DILATING DISK™ VALVE

The selection of orifice sizes to match desirable CV ratings.



Two ANSI Pressure Class 150 valves, side by side. On the left is the 1" Dilating Disk™ Valve, and on the right is a 1" globe valve. Despite the significant size difference between each valve body and the attached actuators, the Dilating Disk™ Valve delivers equivalent flow rate (Cv) to the globe valve and has been engineered to match the same face-to-face dimensions.

Process plant engineers conduct a sizing analysis to determine whether a selected control valve has the appropriate flow capacity and operating characteristics to provide the intended process control. Typically, end user control valve sizing is done in accordance with international standards, and the steps outlined by ISA, ANSI, and IEC.

During the sizing process, plant engineers must avoid choosing an undersized valve, since this would result in process inefficiencies and lowered production. An oversized valve also comes with disadvantages, including poor process control, the need for larger actuators, and unnecessary additional weight and cost.

## CHALLENGE

The Dilating Disk™ Valve is an ideal solution for control valve applications, and is especially well suited to perform the same functions as globe valves. However, the Dilating Disk™ Valve represents a step change in valve design. As such, any new and unique technology can face many barriers to adoption, such as anticipated switching costs and a lack of end user familiarity with performance characteristics and potential applications.

The challenge for Clarke Valve™, therefore, is to ensure that the different sizes and pressure classes of the Dilating Disk™ Valve correspond to commonly available globe valve sizes, and that the CV coefficient, pressure drop, and other performance characteristics are also appropriately matched. Cycle testing also needs to be performed, to ensure reliability.

## SOLUTION

To begin with, the unique geometry of the Dilating Disk™ Valve means that it can deliver a CV equivalent to a much larger globe valve. The centralized flow stream produced by the aperture of the Dilating Disk™ Valve allows for superior process control, while also providing for full port operation with zero pressure drop.

During our process of research and development, we reviewed publicly available performance data for many globe valves, and cross referenced this information with our own testing results. For example, despite the fact that the CV71 has a 1-inch port, it can effectively replace 2-inch, 3-inch, and 4-inch legacy globe valves in many applications.

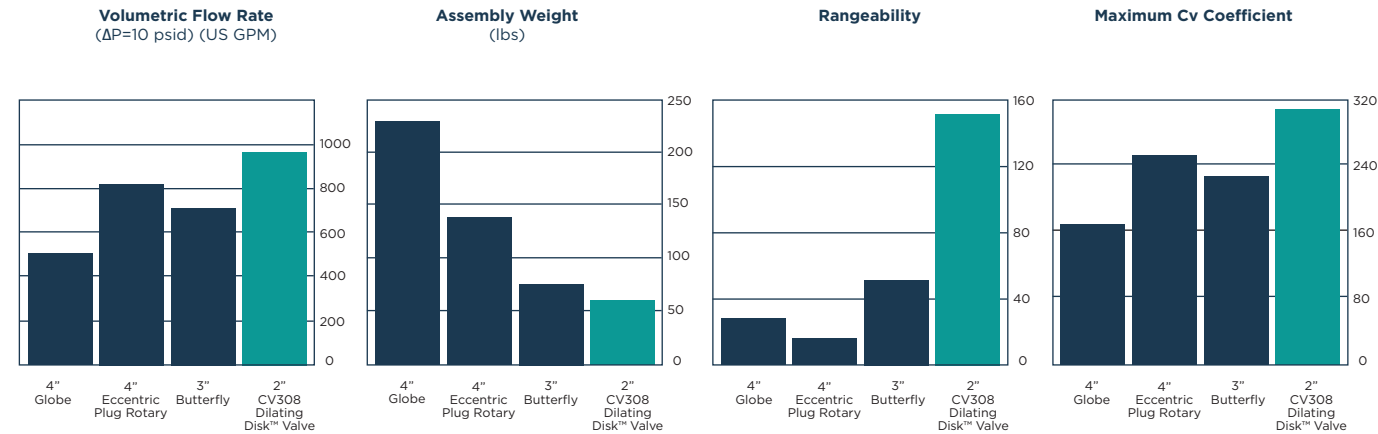

The Dilating Disk™ Valve provides greater volumetric flow, rangeability, and maximum Cv coefficient than larger legacy valve designs, such as the butterfly, globe, and eccentric plug. At the same time, the Dilating Disk™ Valve weighs less than all three comparable valves. With this in mind, Clarke Valve engineers follow a strict methodology for sizing valves, ensuring that the Dilating Disk™ Valve meets or exceeds all of the functional requirements for any legacy valve that it might be replacing. For new build projects, the Dilating Disk™ Valve enables EPCs and end users to design flow control systems that take advantage of the Dilating Disk™ Valve's size and weight advantages.



# EXTENDING OPERATIONAL LIFE AND ENSURING A TIGHT SEAL

The 3-piece O-ring groove created by the valve Petals in the closed position as a solution to survive high-cycle fatigue & wear.

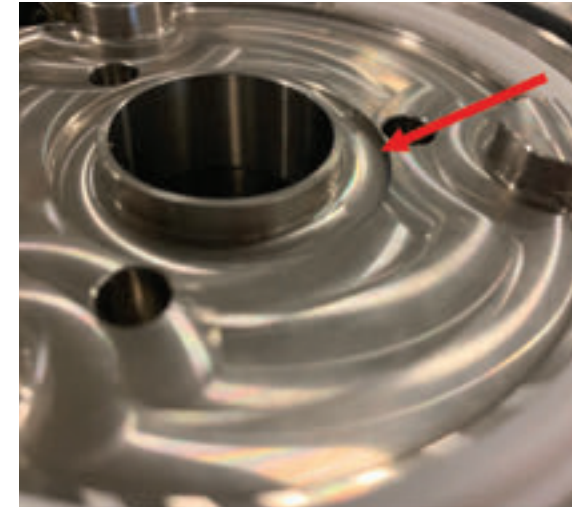
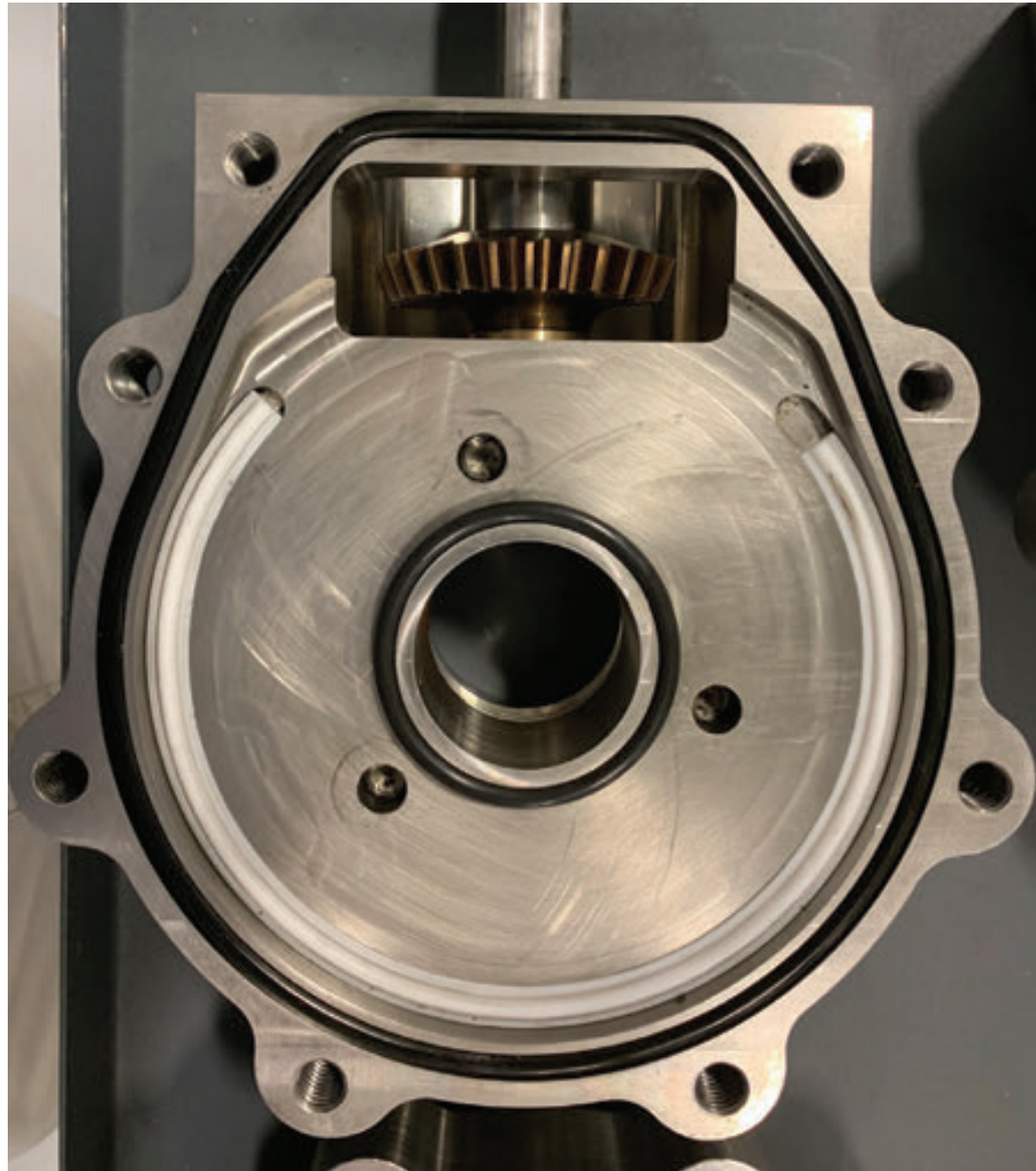

Figure 1: This view illustrates the placement of the interior diameter O-ring (PTFE or metal-filled PTFE) in the body of the Dilating Disk™ Valve. In the top panel, the groove (red arrow) that is machined into each half of the valve body is visible, around the central port. In the bottom panel, the O-ring has been placed into the groove. There is a corresponding groove and O-ring on each of the two halves of the valve body, resulting in a tight seal during shutoff on the upstream and downstream sides of the valve Petals.

The Dilating Disk™ Valve employs a valve mechanism unlike any other design currently used for process control. Unlike the plug and seat combination of the globe valve, or the disc and seat configuration of a butterfly valve, the Dilating Disk™ Valve has 3 precisely machined, interlocking Petals that are capable of ANSI Class IV, Class V, or Class VI bubble-tight shutoff, depending upon the application.

## CHALLENGE

The 3 Petals that function as the throttling mechanism in the Dilating Disk™ Valve are essentially high-strength, robust metal blades that pivot about a Hinge Pin, into (or away from) the central opening of the valve, similar to the motion of scissors. The Petals are driven by a rugged and efficient Ring Gear, which enables the Dilating Disk™ Valve to operate with minimal torque.

Clarke Valve™ engineers needed to devise a method for creating a tight seal on the upstream and downstream faces of the valve Petals, while avoiding erosion, pitting, or tearing of any seals or gaskets during operation.

## SOLUTION

After extensive testing in Clarke Valve's R&D facility, as well as with customers in the real world, our engineers identified a design solution that would protect the inner diameter O-ring seal surrounding the central aperture of the Dilating Disk™ Valve from particle impacts or fluid erosion, while still achieving a tight shutoff.

The axial face of each of the 3 Petals is precisely machined to incorporate a curved arc-circle geometry. This approach

benefits the Dilating Disk™ Valve in 2 ways:

The arc-circle of the Petal prevents a shearing motion across the face of the O-ring by avoiding any pinch points between 2 metal surfaces: the O-ring only comes into contact with any of the valve Petals during the full closed position.

The lip of the arc-circle on all 3 Petals presses tightly against the O-ring in the fully closed position, compressing it against the edge of the valve port and the groove where the O-ring sits in the valve body and cover, effectively creating the second half of the O-ring groove.

Similar to the seals in the bonnet and valve body, Clarke Valve made a design decision to use standard, off-the-shelf sizes for the O-ring surrounding the valve port. While the arc-circle design helps the O-ring to survive high cycle fatigue and wear, the use of standard parts will ensure that any service or replacements of the soft goods in the Dilating Disk™ Valve is cost-effective, and immediately available in case of emergency, for the customer.

## RESULTS

By using the arc-circle design, Clarke Valve has extended the life of the interior diameter O-ring in each Dilating Disk™ Valve, while ensuring a tight seal when the 3 Petals are in the fully closed position. Clarke Valve engineers have conducted 360,000 test cycles on a valve to successfully demonstrate the extended life of the O-ring seal, while maintaining the tight shutoff that results from this design.

Customers therefore benefit from longer periods between maintenance and greater overall uptime, while having total confidence in tight closure at ANSI Class IV, Class V, and even Class VI bubble-tight leakage ratings.

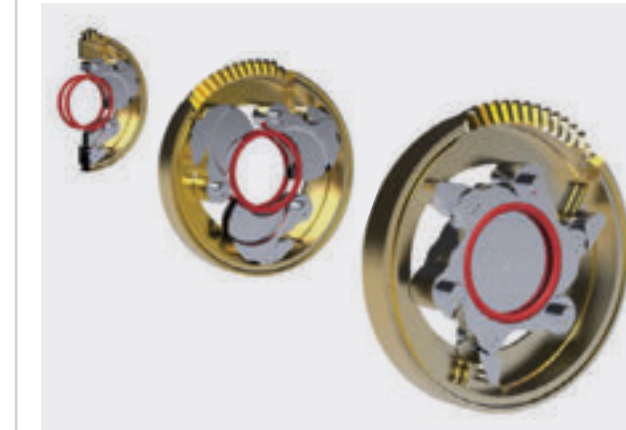
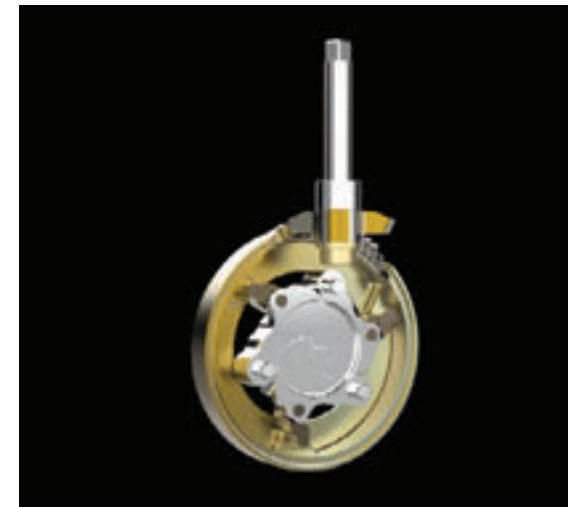

Figure 2: This rendering shows the orientation of the 2 interior O-rings, shown here in red (PTFE or metal-filled PTFE), relative to the 3 Petals and Ring Gear of the Dilating Disk™ Valve, as the Petals move from open to closed. In the first image (left), the valve mechanism is dissected, showing the 2 O-rings which are seated in matching grooves on both halves of the valve body. The valve body has been removed for this illustration, and the flow of process fluids goes straight through the port in the center of these O-rings. In the second image (center), only 1 of the O-rings is completely visible. The O-ring on the posterior of the valve mechanism is mostly obscured by the 3 open Petals of the valve. In the third image (right), the valve aperture is closed, illustrating the tight fit of the O-ring against the concave circle formed by the axial faces of the 3 Petals.



# PRECISION THROTTLING AND TIGHT SHUTOFF WITH MINIMAL TORQUE

The Ring Gear as an appropriate means of driving the movement of the Petals to minimize torque.



*Figure 1: The Ring Gear enables the Dilating Disk™ Valve to deliver precise throttling and tight shutoff, with quarter-turn operation and low torque requirements. A Pinion Gear (top) transfers torque from the Valve Stem to the Ring Gear. The Ring Gear then drives the open/close motion of three interlocking Petals of the Dilating Disk™ Valve via three control Arms.*



*Figure 2: The components that work together to drive the movement of the three interlocking Petals of the Dilating Disk™ Valve: the Pinion Gear (left), the Ring Gear (left-center), one of the three stationary Hinge Pins (right-center), and one of the three pivoting control Arms (right).*

The globe valves used most often for process control typically require significant torque to operate, and the Valve Stem must complete at least one 360-degree rotation, to transition from fully closed to fully open. These torque and rotational requirements lead to larger, heavier actuators, which require more energy to operate.

Reducing the torque requirements of control valves is the most important area of improvement for reducing cost, emissions, and complexity. A reduction in torque requirements also increases the efficiency and reliability of control valves.

Although butterfly valves and ball valves often cycle from fully closed to fully open on a 90-degree quarter-turn, they still require significant operating torque, and produce fluid effects that make them less than ideal for process control applications.

## CHALLENGE

How can valve OEMs deliver quarter-turn operation, with minimal torque, while still providing precision throttling and tight shutoff?

## SOLUTION

With the patented design of the Dilating Disk™ Valve, the engineering team at Clarke Valve™ has effectively addressed the challenge of reducing torque requirements and providing precision control and tight shutoff, through the use of a Ring Gear.

The Ring Gear in a Dilating Disk™ Valve is a beveled gear, and it is mounted at a 90-degree angle to the Pinion Gear. The Pinion Gear transfers torque from the actuator and Valve Stem to the Ring Gear, using a quarter-turn motion to cycle from fully closed to a fully open port.

Energy is then transferred from the Ring Gear to the three valve Petals by control Arms that link the Ring Gear to each Petal. The Ring Gear is connected to each arm, and each arm is then connected to the other end of the Petal. There are also three Hinge Pins mounted in the valve body, that act as a stationary connection point for each Petal. Through this mechanism, the rotating motion of the Ring Gear is transformed into the pivoting movement of each Petal, into (or away from) the center of the valve port. The Ring Gear essentially provides a torque multiplication effect, like a bicycle gear or the transmission in a car.

In addition to the leverage provided by this mechanism, the movement of the three valve Petals also occurs in such a way as to further minimize torque requirements. In the Dilating Disk™ Valve, the three Petals open and close perpendicular

“Energy is then transferred from the Ring Gear to the three valve Petals by control Arms that link the Ring Gear to each Petal.

to the flow of any process fluids being controlled, encountering minimal flow-related resistance. If you’ve ever seen a car become submerged under water, on television or in a movie, you’re familiar with this concept. The people trapped inside the car are unable to open the door of the car, against the force of the fluid pressure surrounding the vehicle. However, they can easily roll down the window, as the window is moving perpendicular to the force/pressure of the water.

As a result of this design feature, the Dilating Disk™ Valve does not require the high amounts of torque needed by a butterfly or globe valve, each of which need to push against the force of the flow, for throttling or shutoff. In fact, no matter how much the pressure or flow rate are increased in a given process, the Dilating Disk™ Valve does not require any additional torque to open and close. The same cannot be said for a butterfly or a globe valve, both which require more torque to operate, as the pressure increases in the pipe.

To further maximize efficiency and achieve reliable operation from the gearing in the Dilating Disk™ Valve design, Clarke Valve has worked closely with our supplier Tracey Gear. Together, we have optimized the alignment and synchronization between the Pinion Gear and Ring Gear, by ensuring consistent tolerances between the gears. This degree of precision helps to prevent any backlash or play in the mechanism, delivering smooth and controlled operation. The reduction or elimination of play also minimizes energy loss and ensures the efficient conversion of torque into the opening and closing function of the valve.

## RESULTS

By design, the Ring Gear is an efficient means of transmitting torque into the functional motion of the Dilating Disk™ Valve. Only a quarter-turn of the Valve Stem is required for a dynamic range of process control, and the gearing of the valve ensures that minimal energy is lost.

These features allow customers who deploy the Dilating Disk™ Valve to use much smaller, lighter, and more energy efficient actuators, thereby reducing the cost, complexity, and energy consumption, as described above, while increasing reliability and efficiency.



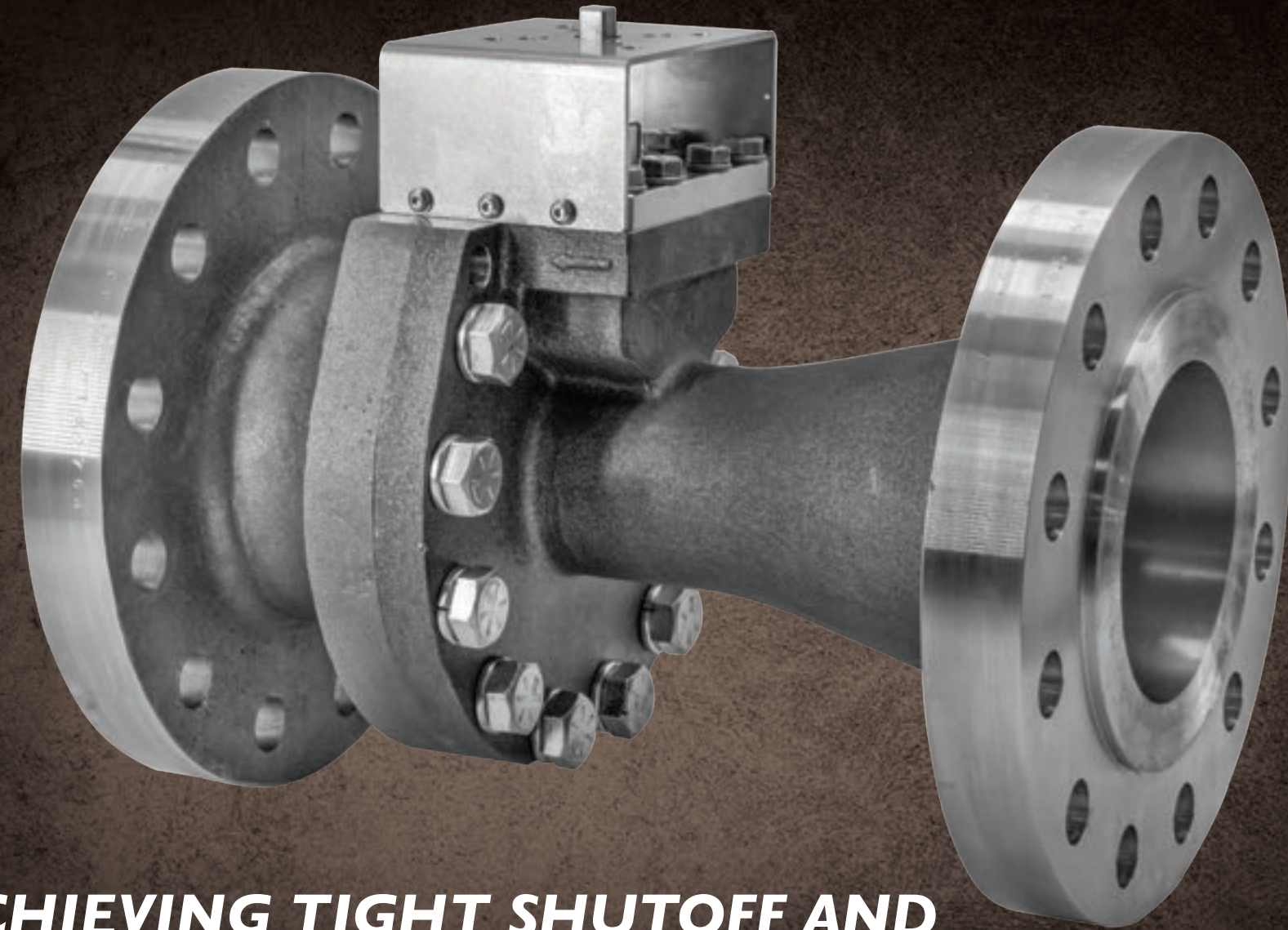

## ACHIEVING TIGHT SHUTOFF AND EXTENDING COMPONENT LIFE

The interlocking seal and rib combination as a safeguard against seat leakage, high cycle fatigue, and wear.

“ The combination of all these elements allows the Dilating Disk™ Valve to seal as tightly as any comparable control valve, and deliver a centralized flow stream, while minimizing the high cycle fatigue and wear that occur with designs like the iris valve.”

**T**he Dilating Disk™ Valve is a unique and innovative control valve design that signals a distinct departure from the globe, ball, butterfly, eccentric plug, and other variations used for shutoff and process control over the last 100 years.

The closest comparison to the Dilating Disk™ Valve is the iris valve, which has seen limited market penetration as a control valve due to a few key flaws. 1) The angular elements of the iris are in constant contact with each other, even when the valve is fully open. This high amount of metal-to-metal component contact leads to high cycle fatigue and wear for the iris valve. 2) The sealing capability of the iris is limited, with limited leakage control along the adjacent boundaries of each component. 3) There is always a small opening at the center of the iris – even when the components of the iris are machined to very tight tolerances, gas or liquid at high pressure will leak through this pinhole opening, and prevent the iris valve from achieving Class IV, Class V, or Class VI leakage ratings.

### CHALLENGE

Clarke Valve™ set out to capitalize on the positive elements of an iris design—central flow stream, and a dynamically variable orifice—while addressing the seat leakage, high cycle fatigue, and wear that cannot be prevented for the iris valve, due to its inherent design flaws.

### SOLUTION

To address the wear and leakage of the iris valve, Clarke Valve has developed a control valve aperture comprised of 3 curved, interlocking Petals.

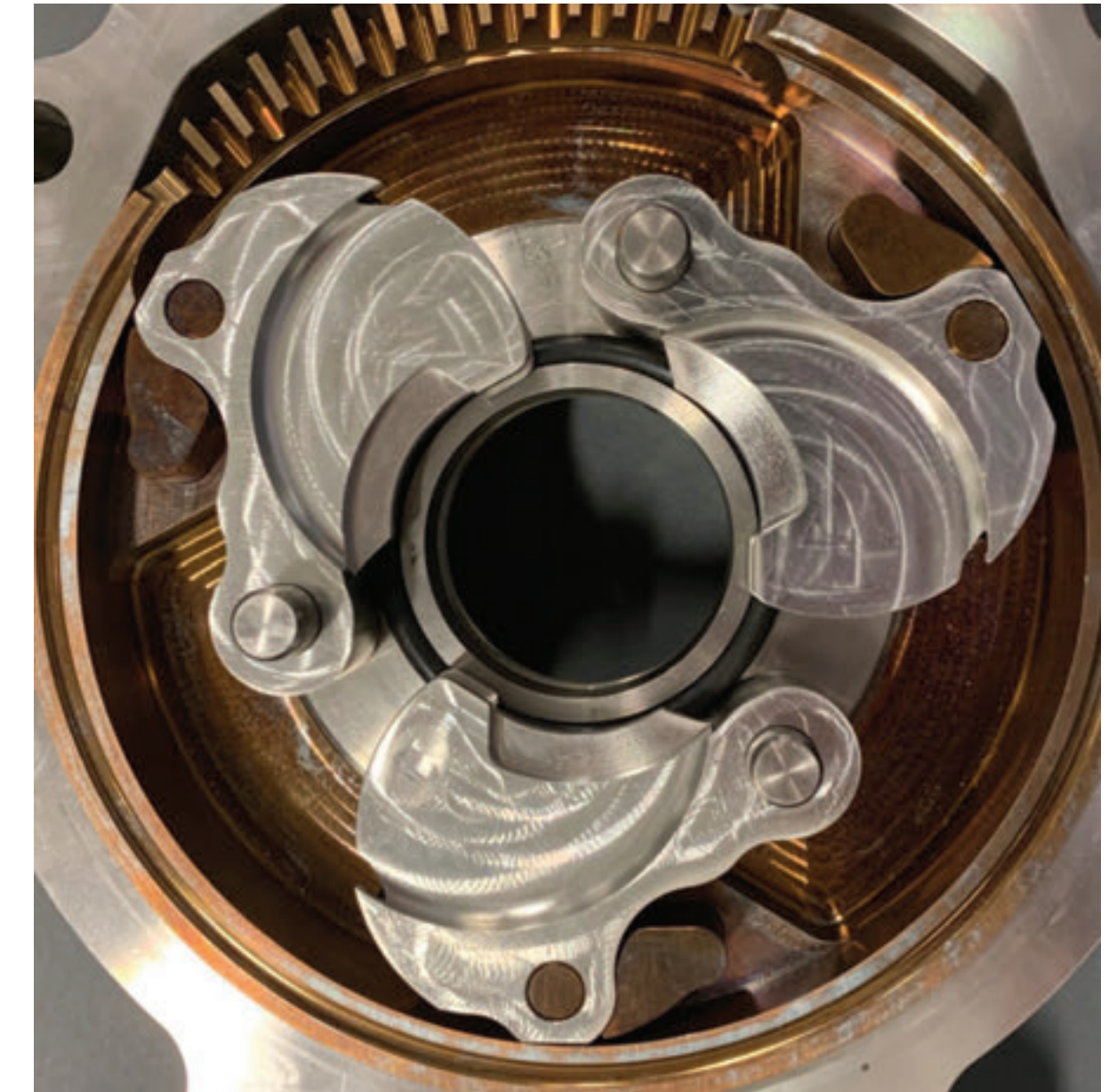

*Figure 1: The aperture of the Dilating Disk™ Valve, comprised of 3 interlocking Petals that pivot on a Ring Gear within the valve body. Here, one half of the valve body has been removed, and the Dilating Disk™ Valve is in the fully open position.*



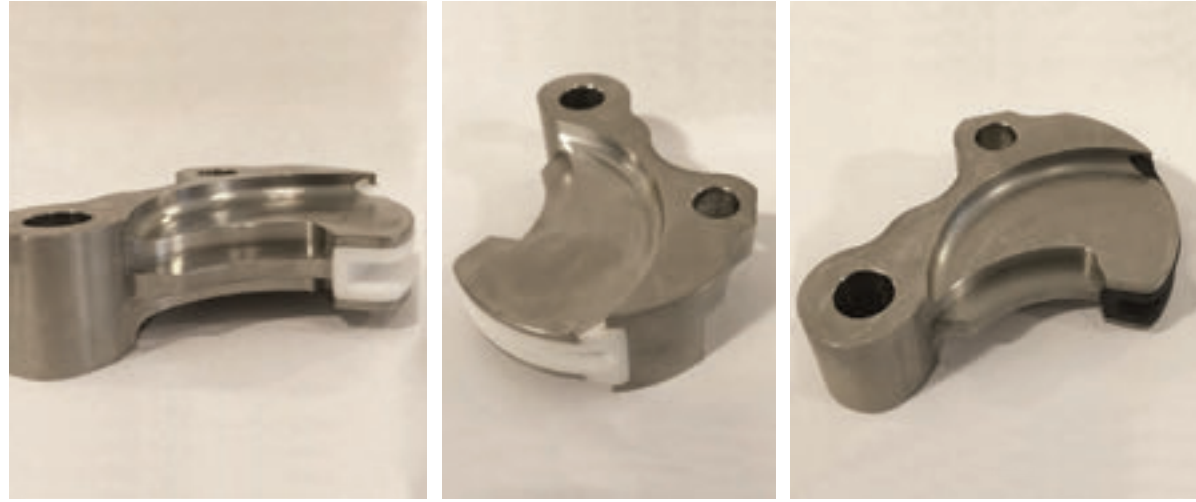

Figure 2: Individual valve Petals shown from multiple angles, and with 2 types of sealing material. The left image illustrates the inner sealing surface of a Petal, with the rib/male feature seen straight on. The seat/female feature in this Petal is equipped with a white PTFE seal. Another angle (center) of the same Petal shows the full length of the seat/female feature and white PTFE seal, as well as the arc-circle concavity on the Petal's face, which compresses the interior O-ring. A third view (right) shows a Petal equipped with a black elastomer seal. The hole at the narrow end of each Petal is for the stationary Hinge Pin, while the hole at the wide part of the Petal is for the pivoting control arm.

First, we addressed the challenge of friction and wear by designing the Dilating Disk™ Valve to prevent contact between the 3 Petals during operation: the Petals of the Dilating Disk™ Valve are only in contact with each other when the valve is fully closed. As soon as the valve begins to open, the Petals are moving away from each other to create a central aperture, without any of the sliding contact of the iris valve.

Next, we addressed the potential for leakage by designing each Petal to feature a cavity along its top/outer surface that aligns with a protruding rib on the lower/inner surface of the adjacent Petal. The result is that each valve has a male and female sealing component, which are machined to high precision. Extensive testing has enabled us to identify the optimal design ratio of rib height to width, and the corresponding dimensions for the sealing cavity for each valve trim and size. These design specifications address not only performance, but also manufacturability: we find the ideal seal-to-rib combination to achieve the highest working pressure class (ANSI 1500), while ensuring that

each Petal can be machined with maximum efficiency and minimal material waste.

The seal between these interlocking surfaces is further enhanced by the addition of soft material to the cavity on each Petal, which can conform more tightly to the metal on the adjacent rib than a metal-to-metal connection would. For many applications, elastomer is used, which provides more flexibility and therefore, greater sealing ability, when compressed against the metal sealing rib on the adjacent Petal. Through testing, we have found that a durometer between 60 and 80 is most effective, depending upon the application and the liquid or gases being handled by the valve.

When a more durable material is required—for high velocity fluids with greater erosion potential, or corrosive fluids—we can equip the sealing surfaces of each Petal with PTFE. In all cases, the elastomer or PTFE seals are designed to be recessed within the interlocking cavity, with minimal exposure to the fluids being controlled.



Figure 3: The 3 Petals of the Dilating Disk™ Valve are shown in a throttling position (left), illustrating the manner in which the valve aperture is controlled by the Petals pivoting in unison. On the right, 1 Petal has been removed, providing a direct view of the interlocking seat-and-rib mechanism between the 2 remaining Petals. The metal rib/male component on the inner curve of each Petal fits precisely into the seat/female component (fitted with a PTFE seal, here) on the back of its neighboring Petal. The removal of this Petal also exposes 1 of the 2 black elastomer O-rings, which form a seal between the central valve port and the 3 Petals, on both sides of the valve mechanism.

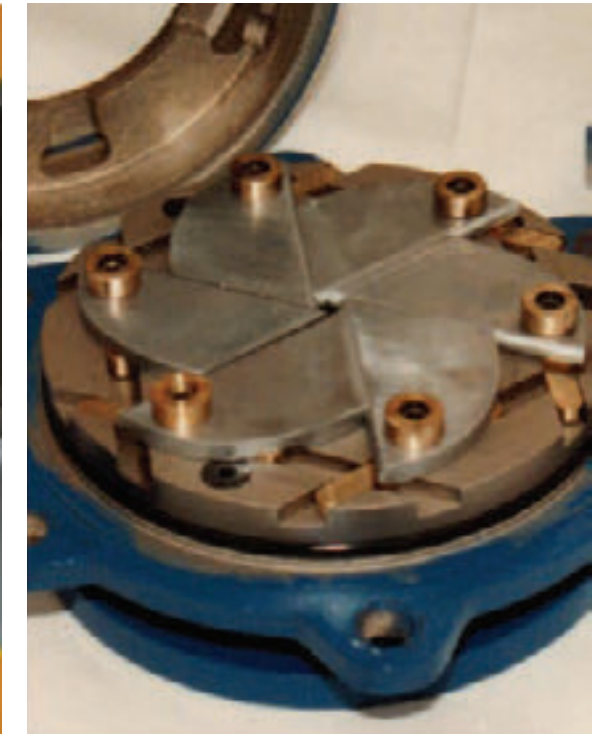
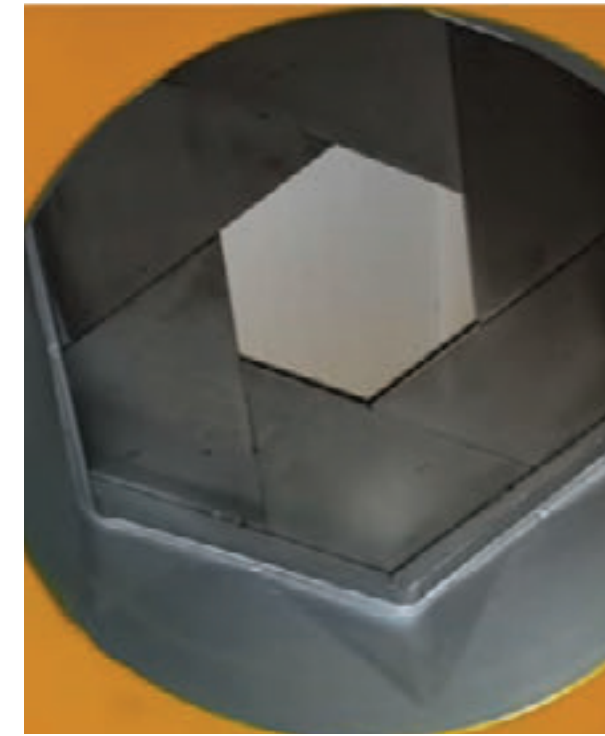
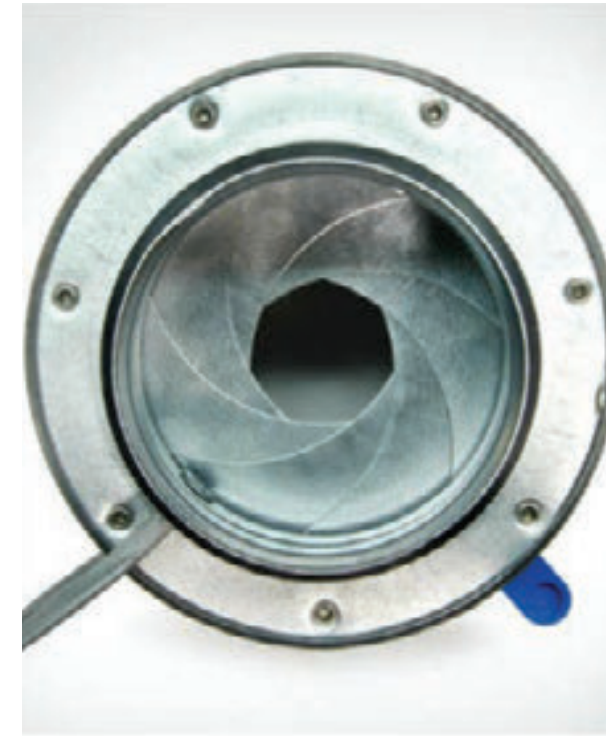

Figure 4: Several examples of iris valve designs. In addition to the segmented aperture design shown here (typically constructed with metal) there is also a “diaphragm iris” valve which uses a single, dilating piece of pliable material to open and close the valve aperture.

“ When a more durable material is required—for high velocity fluids with greater erosion potential, or corrosive fluids—we can equip the sealing surfaces of each Petal with PTFE.

The other leakage point of the iris valve—the central meeting point of the valve elements, which is never completely sealed—is addressed by the design of the interlocking notch at the end of each Dilating Disk™ Valve Petal. In a forthcoming post, we will outline the design of this critical feature of the valve.

Finally, as we will describe in greater detail elsewhere, there are 2 interior diameter O-rings that ensure a tight seal between the 3 Petals and the ports on either side of the aperture. The O-ring sits in a groove that is machined into the valve body around the circumference of each port. The face of each Petal is also machined to include an arc-circle concavity that compresses the O-ring when fully closed.

## RESULTS

The combination of all these elements allows the Dilating Disk™ Valve to seal as tightly as any comparable control valve, and deliver a centralized flow stream, while minimizing the high cycle fatigue and wear that occur with designs like the iris valve. When appropriate torque is applied, the Dilating Disk™ Valve can achieve ANSI Class V and Class VI bubble-tight shutoff using elastomer seals. For applications that require PTFE, we can achieve Class IV shutoff.

Furthermore, the deployment of 3 identically machined Petals as the control and sealing mechanism also provides economies of scale, allowing Clarke Valve to reduce the cost of each Dilating Disk™ Valve sold.





CONFIGURE YOUR  
**DILATING DISK™**  
**VALVE**

Take the first step to improving flow control operations, maintenance and cost of ownership, configure a Dilating Disk™ Valve for your unique application.



42 WHITECAP DRIVE  
NORTH KINGSTOWN, RI 02852  
SALES@CLARKEVALVE.COM

PHONE: (401) 667-7880  
(800) 401-6618  
FAX: (401) 667-0045



**Clarke Valve**

World's Most Compact & Efficient Control Valve